



## Repair Part Sheet

### BMSL- 200 Cylinder

Form No. BMSL200RP Rev. A Date: 20.5.2014



BELIUM Cylinders should be repaired only by a qualified operator or Authorized BELIUM Service Centers. Use Only BELIUM or other approved hydraulic oil. Release pressure in hydraulic system and disconnect hose(s) before making repair.

### Parts List

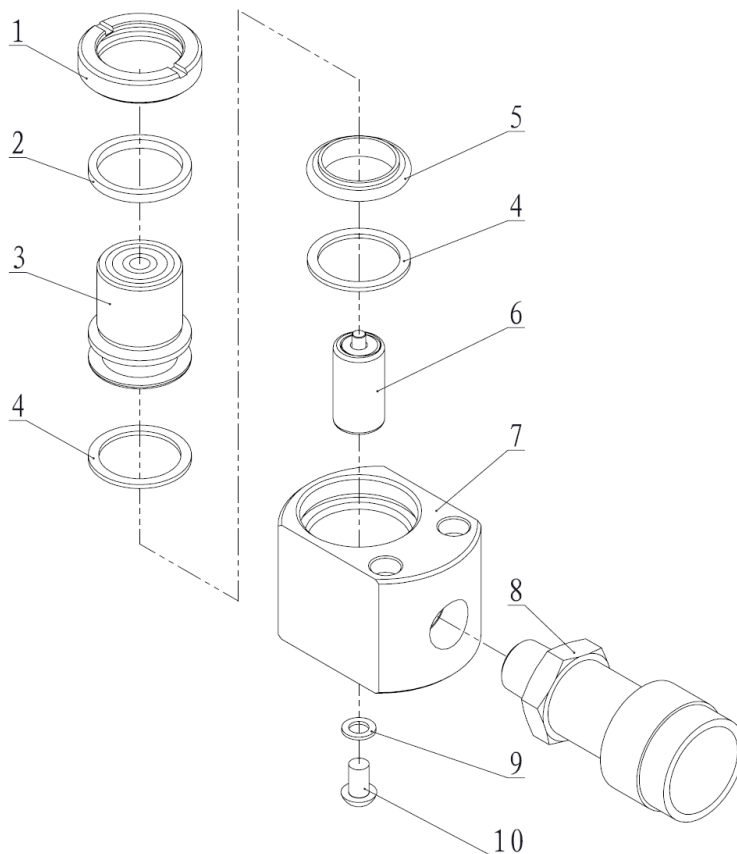

Item No.10: Torque to 22-44 ft. lbs.  
[30-60 Nm].

Item No.8: Torque to 22-44 ft. lbs.  
[30-60 Nm].

Apply Teflon tape or Loctite 545 thread sealant. Leave first complete thread free to prevent tape particles from entering into the hydraulic system.

Item No.	Part Number	Description	Quantity
1	BMSL200-1	Guide Ring	1
2★	21687	Wiper Ring	1
3	BMSL200-3	Piston Rod	1
4★	21311	Gasket	2
5★	21004	T-ring	1
6	31008	Spring Assembly	1
7	BMSL200-2	Cylinder	1
8	BAC-201A	Coupler	1
9★	QY2-13	Copper Washer	1
10	11003	Bolt	1

★ Items included in Repair Kit, Repair Kit order number: **BMSL200-RP-A**