



Repair Part Sheet

BMSL- 750 Cylinder

Form No. BMSL750RP Rev. A Date: 20.5.2015



BELIUM Cylinders should be repaired only by a qualified operator or Authorized BELIUM Service Centers. Use Only BELIUM or other approved hydraulic oil. Release pressure in hydraulic system and disconnect hose(s) before making repair.

Parts List

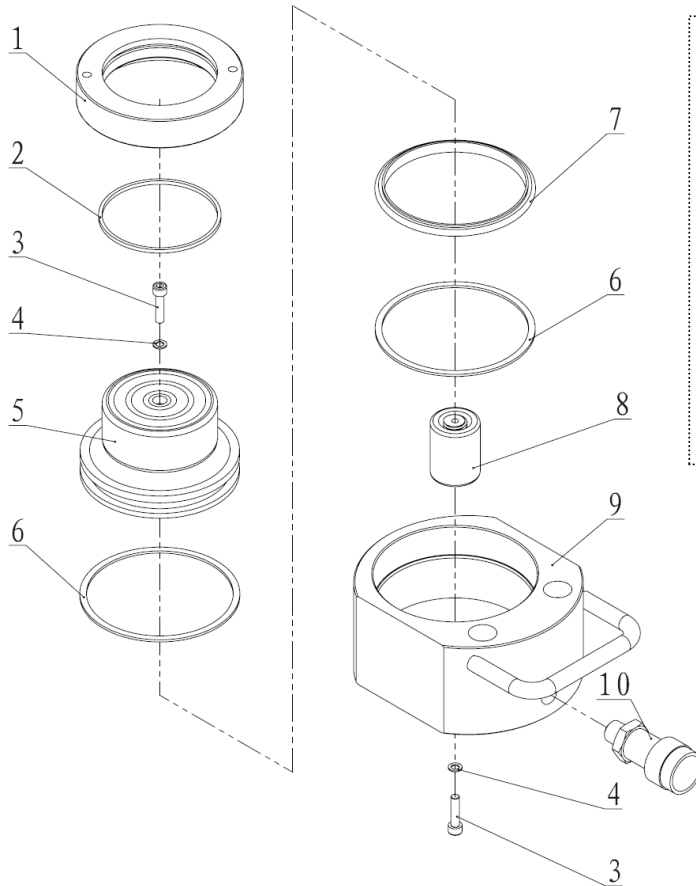

Item No.3: Torque to 22-44 ft. lbs. [30-60 Nm].

Item No.10: Torque to 22-44 ft. lbs. [30-60 Nm].

Apply Teflon tape or Loctite 545 thread sealant. Leave first complete thread free to prevent tape particles from entering into the hydraulic system.

Item No.	Part Number	Description	Quantity
1	BMSL750-1	Stop Ring	1
2★	21599	Wiper Ring	1
3	11005	Bolt	2
4★	QY2-13	Copper Washer	2
5	BMSL750-3	Piston	1
6★	21058	Gasket	2
7★	21011	T-ring	1
8	31055	Spring Assembly	1
9	BMSL750-2	Cylinder	1
10	BAC-201A	Coupler	1

★ Items included in Repair Kit, Repair Kit order number: **BMSL750-RP-A**